

40 G-72 1F

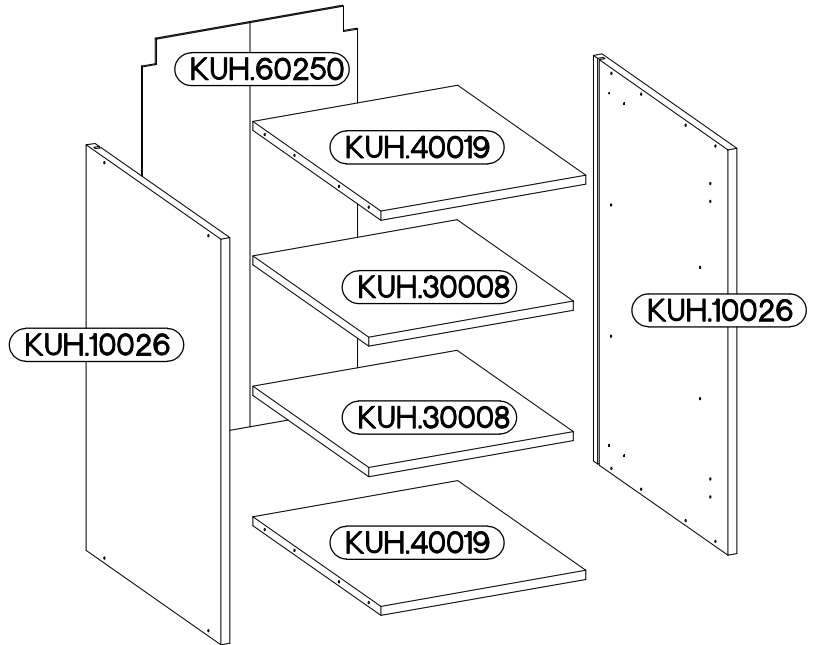

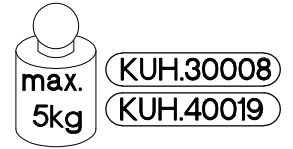
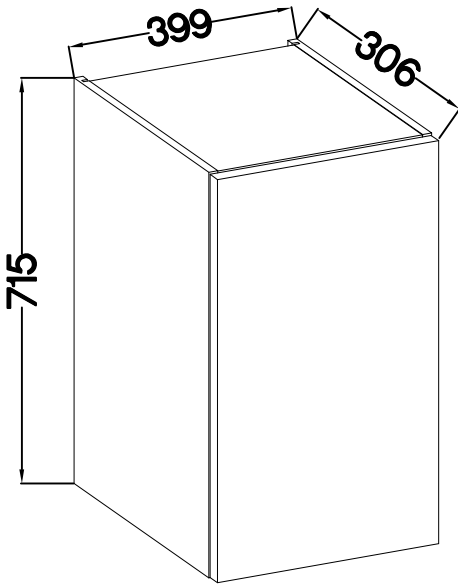
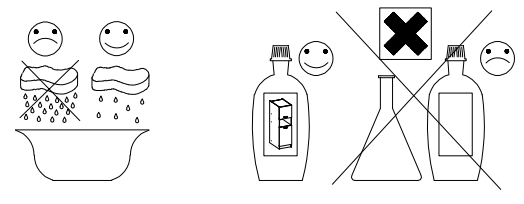
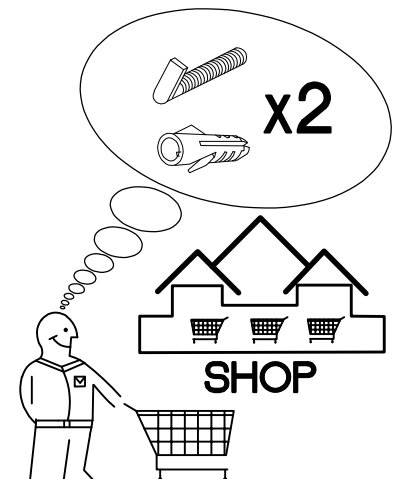

Ersatzteil Nummer	Dimension
KUH.10026 x2	715x290x16
KUH.30008 x2	366x250x16
KUH.40019 x2	367x276x16
KUH.60250	713x385x2,5

$\pm 8 \times 30\text{mm}$ A 8	$6,4 \times 50\text{mm}$ B 8	 E1 8	$\pm 35/0\text{mm}$ [CD] HG 2
$\pm 5/19\text{mm}$ J 8	 K 2	 O 1	$\pm 3,5 \times 13\text{mm}$ P5 4
			$\pm 3,0 \times 20\text{mm}$ P7 8-10
			$\pm 4,0 \times 30\text{mm}$ P8 4

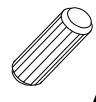

ISM-KUH-01615

1

$\pm 8 \times 30 \text{mm}$  A 8	$\pm 4.0 \times 30 \text{mm}$  P8 4	 K 2
---	--	--

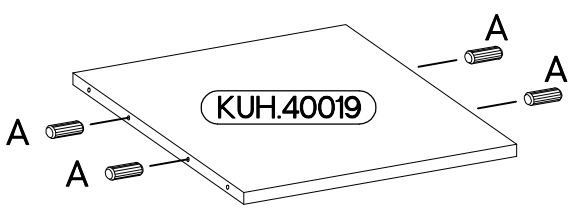
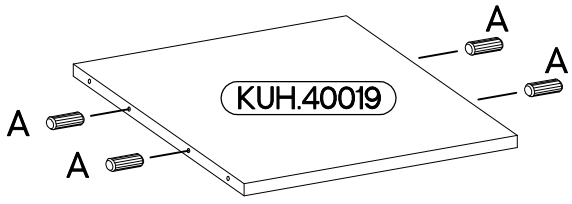
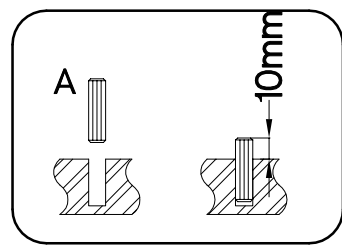
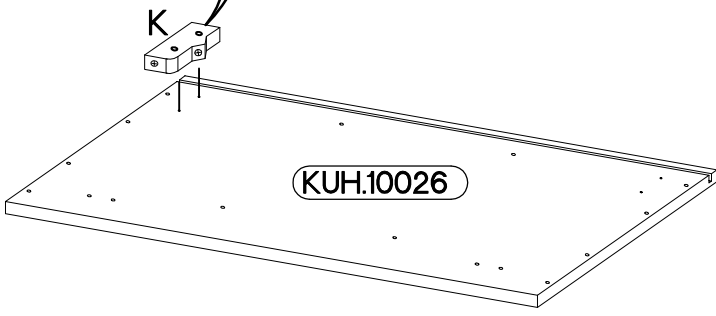
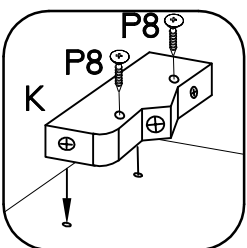
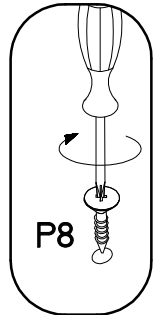
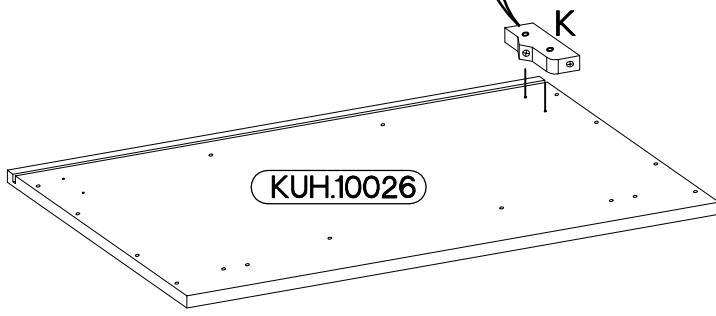
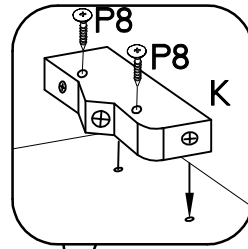
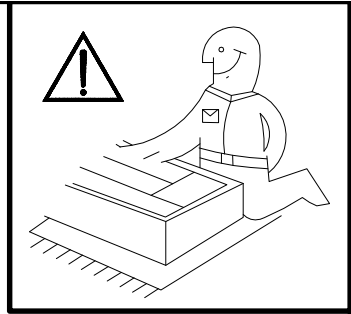

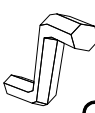
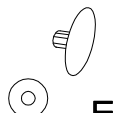

2

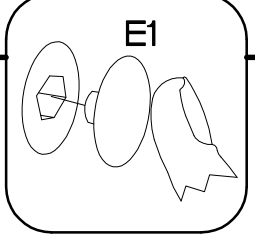
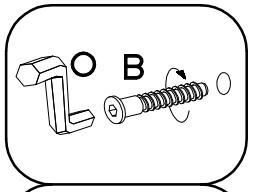
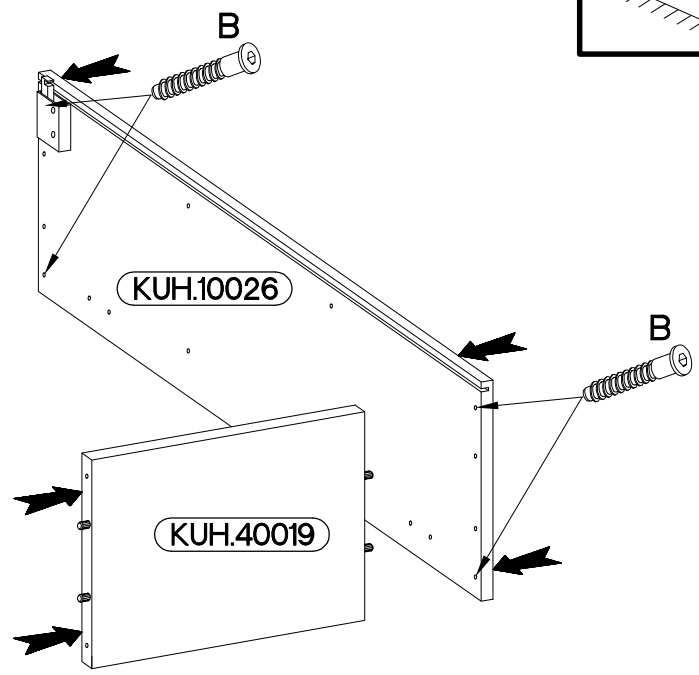
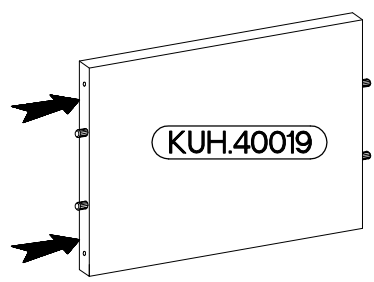
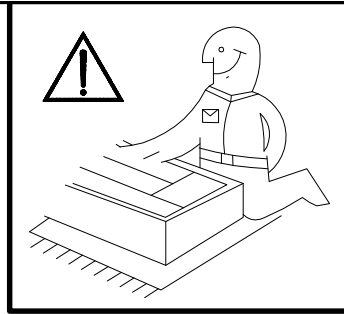
6,4 x 50mm		
		
B	O	E1
4	1	4

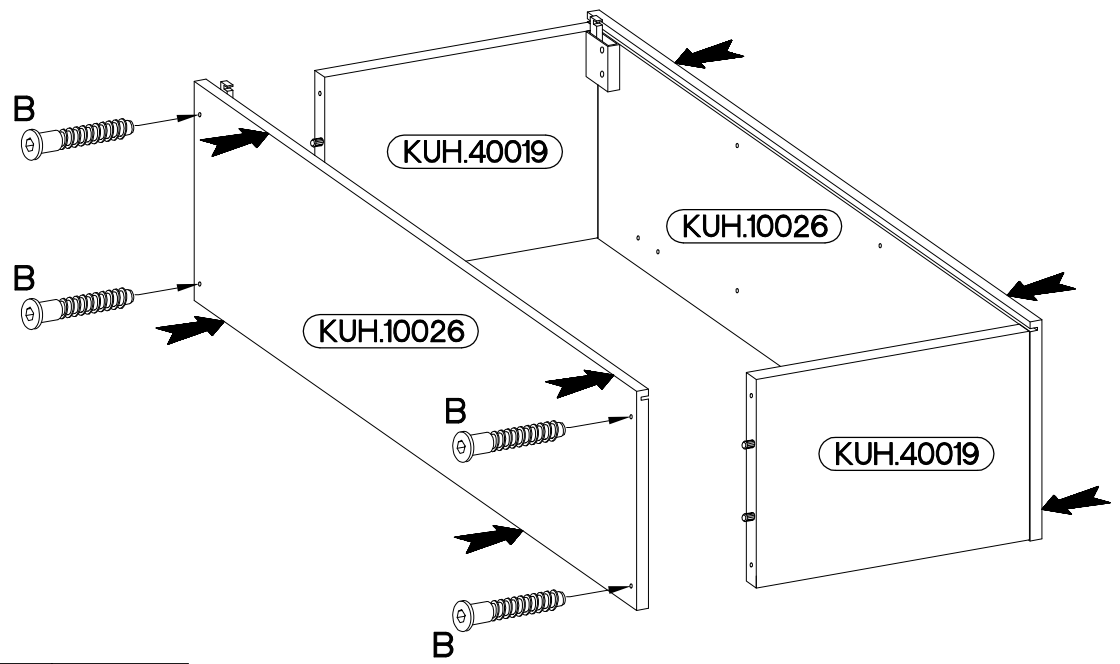

3

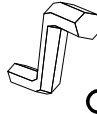
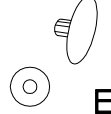

6,4 x 50mm		
		
B	O	E1
4	1	4

4

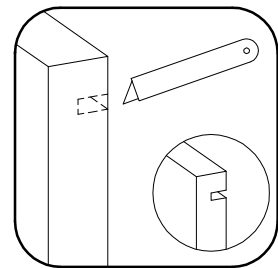
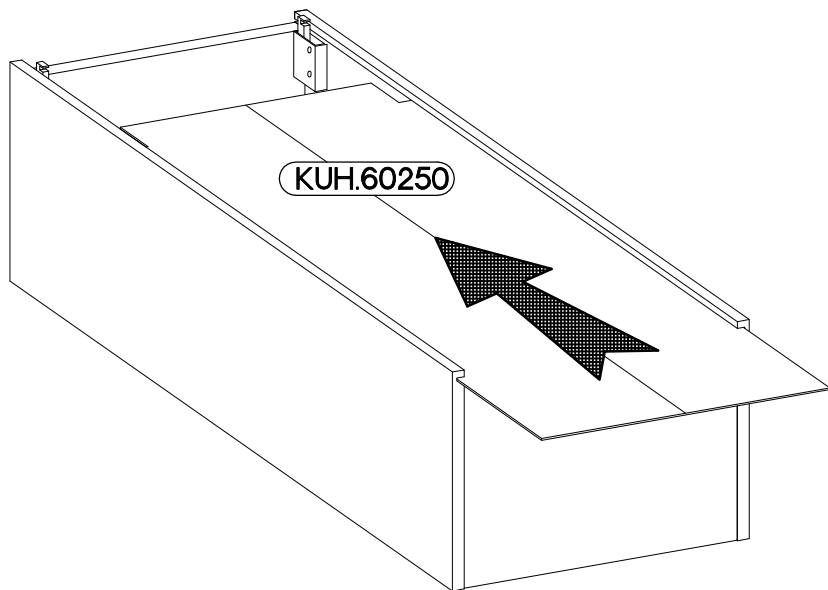
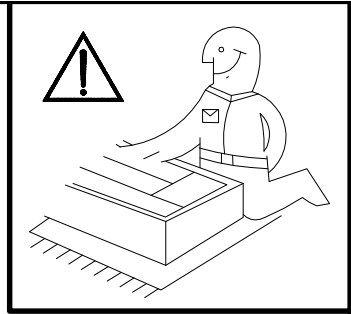

5

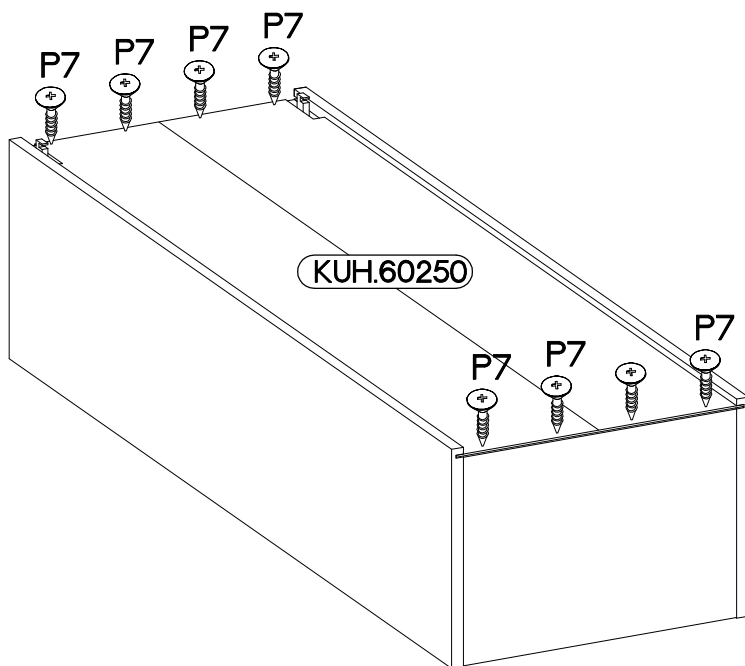
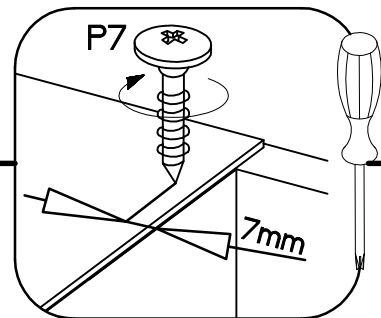
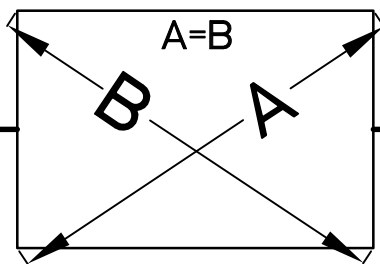
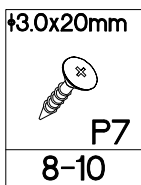

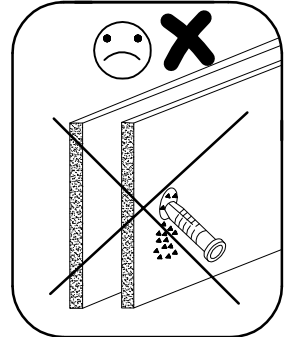
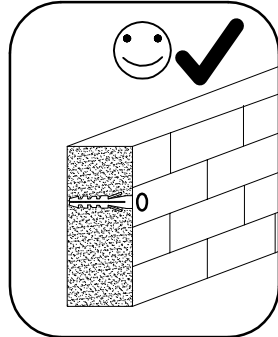
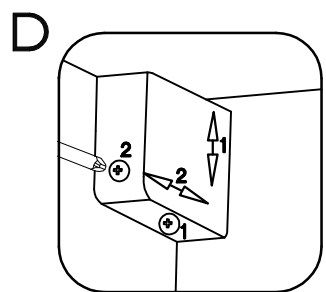
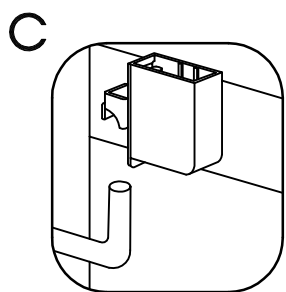
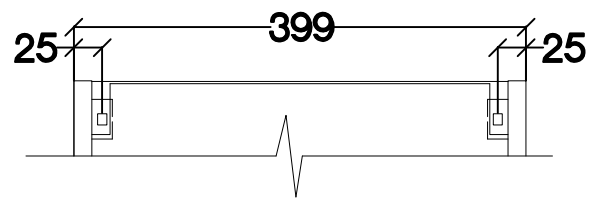
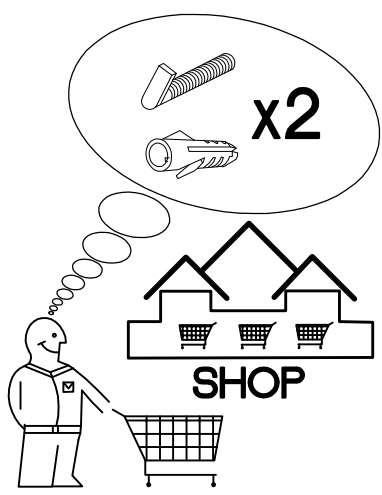
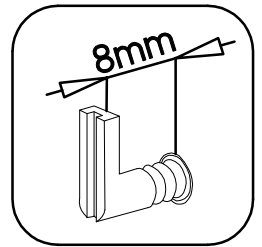
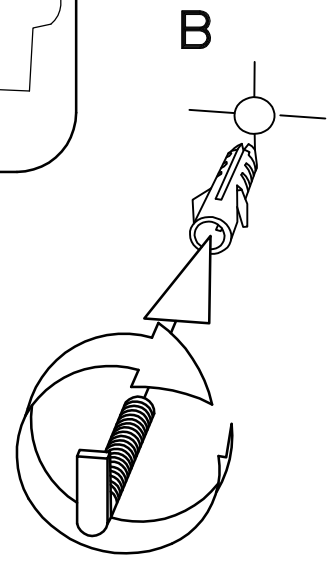
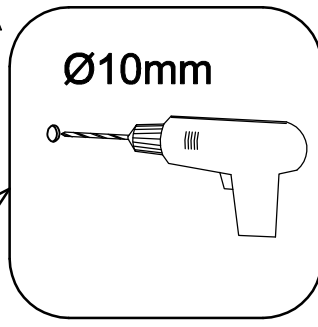
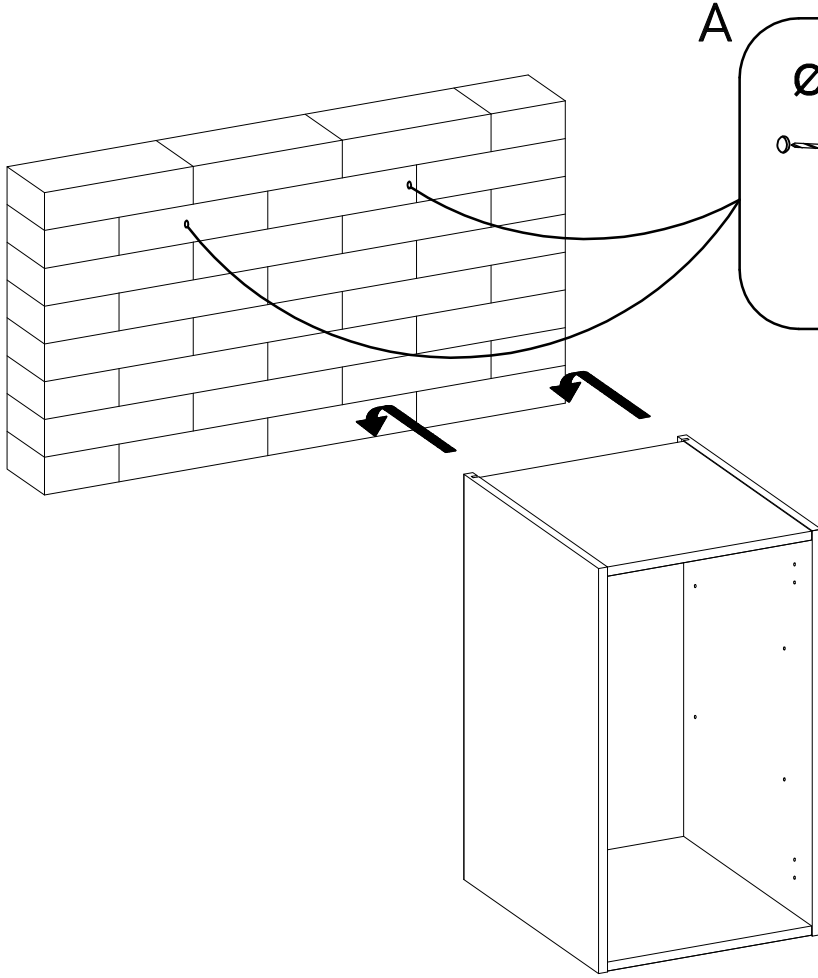
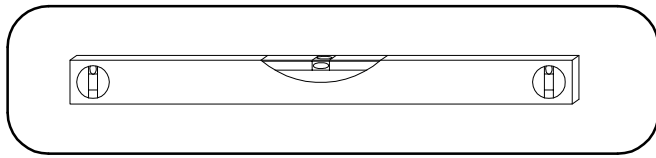

7

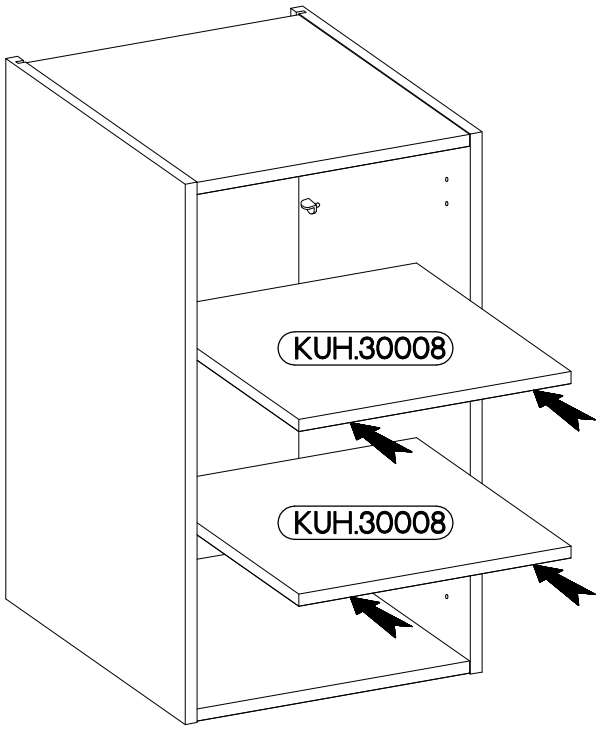
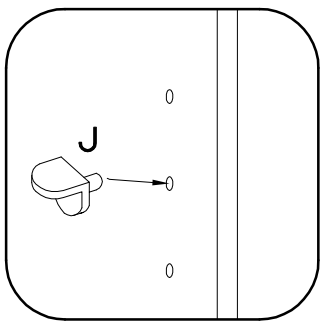
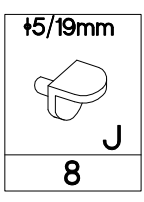

8

FRONT

